

# Big Blue® 400 and 500

Issued April 2008 • Index No. ED/10.8

Engine-Driven  
Welder/Generator 

## Quick Specs

### Heavy Industrial Applications

Heavy Construction  
Structural Steel  
Maintenance and Repair Rigs  
Mining Maintenance  
Process Piping  
Sheet Metal

### Processes

Stick (SMAW)  
MIG (GMAW)  
Flux Cored (FCAW)  
DC TIG (GTAW)  
Submerged Arc (SAW)  
Stud Welding  
Air Carbon Arc (CAC-A)  
**400:** (Rated) 5/16 in (8 mm) Carbons  
(Capable) 3/8 in (9.5 mm) Carbons  
**500:** (Rated) 3/8 in (9.5 mm) Carbons

### Output Range

**400 CC:** DC Stick 55–500 A DC/TIG 55–500 A  
**400 CC/CV:** DC Stick 40–550 A DC/TIG 20–350 A  
MIG/FCAW 14–40 V  
**500 CC:** DC Stick 65–600 A DC/TIG 65–600 A  
**500 CC/CV:** DC Stick 40–600 A DC/TIG 20–425 A  
MIG/FCAW 14–40 V

### Generator Output Rated at 104°F (40°C)

5500 Watts Peak—4000 Watts Continuous  
**400:** 15,000 Watts 3-Phase/12,000 Watts 1-Phase\*  
**500:** 20,000 Watts 3-Phase/12,000 Watts 1-Phase\*

\*Deluxe models only.

**Accu-Rated™—Not Inflated  
Generator Power**

## The Power of Blue.®

Prior Big Blue 302 owners now have a choice between the Big Blue 400 or the PRO 300.

**Engine gauges** standard on all models indicate engine oil pressure, coolant temperature.

**Designed for fleet owners** that demand the ultimate in reliability and performance.

**Enclosed robust case design** protects internal components from impact and allows air flow to cool and prolong the life of the engine. Also reduces sound levels.

**Quick and easy maintenance** with single-side access to oil level check, oil fill, oil filter, fuel filter and air cleaner.

**Remote toolless oil drain** allows oil to be drained without getting under the engine and reduces the chance of oil spillage.



**CC/CV Models: The Vault—ultimate control board reliability.** See page 3.

# BUILT TOUGH



**Heavy duty industrial engine choices** designed, built and proven to operate over 10,000 hours before the first basic overhaul.

**Improved!**  
Maintenance Displays!

### NEW! Meter maintenance displays.

- Hour meter function
- Oil change interval
- High coolant temperature and low oil pressure shutdowns
- Low fuel shutdown—engine shuts down before system runs out of fuel, making restarts easy.

**Arc-Drive** makes welding easy. Automatically enhances Stick welding, especially on pipe, by focusing the arc and preventing the electrode from going out.

**Hot Start™** provides positive Stick electrode starts making it easy to start all types of electrodes and it also works great for bead tie-ins.

**Weatherproof Lexan® nameplate** resists cracking and fading, and is color-coded for ease of operation.

**GFCI receptacle** as required on most job sites to protect operators from electrical hazards.

**CSA and NEMA compliant for welders.** Degree of protection provided by enclosure IP23.



Big Blue 400 CC/CV  
Deluxe Model

**TRUE BLUE**  
3YR. WARRANTY

Welder/generator is warranted by Miller for 3 years, parts and labor.  
Engine is warranted separately by engine manufacturer.

MADE IN **USA**  
APPLETON, WI



**Miller Electric Mfg. Co.**  
An Illinois Tool Works Company  
1635 West Spencer Street  
Appleton, WI 54914 USA

**International Headquarters**  
Phone: 920-735-4505  
USA FAX: 920-735-4134  
Canadian FAX: 920-735-4169  
International FAX: 920-735-4125

**Web Site**  
www.MillerWelds.com



# Big Blue 400 and 500 CC Specifications (Subject to change without notice.)



Model	Welding Mode	Weld Output Range	Weld Output Rated at 104°F (40°C)	Max. Open-Circuit Voltage	Generator Output Rated at 104°F (40°C)	Dimensions**	Weight (without fuel)***
Big Blue 400 CC	CC/DC	55–500 A	400 A at 36 V (14.4 kW),* 100% Duty Cycle 450 A at 38 V (17.1 kW),* 60% Duty Cycle 500 A at 30 V (15 kW), 40% Duty Cycle	95	<b>Peak:</b> 5500 watts <b>Continuous:</b> 4000 watts, 34/17 A, 120/240 VAC, 50/60 Hz while welding	H: 43 in (1092 mm) W: 28-1/2 in (724 mm) D: 64-7/16 in (1637 mm)	<b>Perkins:</b> 1545 lb (701 kg) <b>Deutz:</b> 1655 lb (751 kg)
Big Blue 500 CC		65–600 A	500 A at 40 V (20 kW),* 100% Duty Cycle 550 A at 34 V (18.7 kW), 60% Duty Cycle 600 A at 30 V (18 kW), 40% Duty Cycle				<b>Perkins:</b> 1565 lb (710 kg) <b>Deutz:</b> 1695 lb (769 kg)

\*NEMA EW1 (ANSI C87.1) Class (1) output ratings. \*\*Additional 7 in (178 mm) to top of exhaust. \*\*\*Additional 190 lb (86 kg) when fuel tank is full.

CSA certification by Canadian Standards Association.

## Big Blue 400 and 500 CC Control Panel

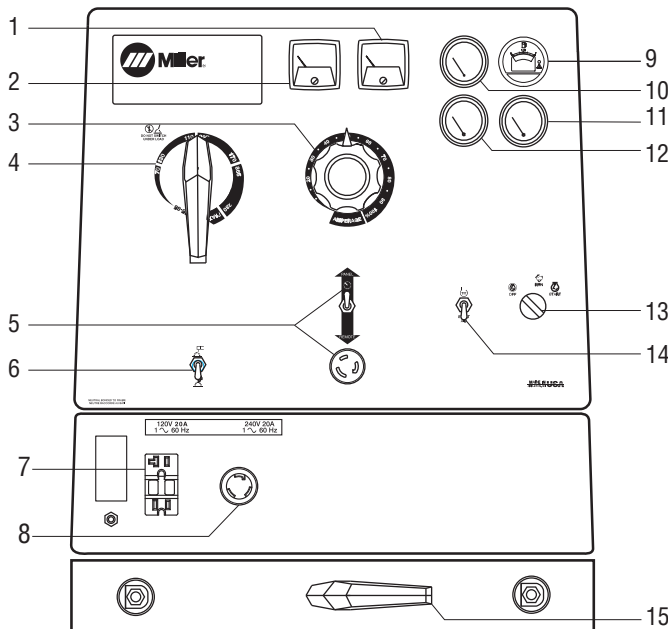

1. DC Ammeter\*
2. DC Voltmeter\*
3. Amperage Adjust Control
4. Amperage Range Switch
5. Amperage Adjust Switch and Remote Amperage Adjust Receptacle
6. Stick/TIG Selector Switch
7. 120 VAC, 20 A GFCI Duplex Receptacle
8. 240 VAC, 30 A TwistLock Receptacle (NEMA L6-30)
9. Fuel Gauge/Hour Meter/Oil Change Interval Engine Shutdown Indicator
10. Engine Oil Pressure Gauge
11. Battery/Voltmeter\*
12. Engine Coolant Temperature Gauge
13. Engine Control Switch
14. Starting Aid Switch
15. Polarity Switch\*

\*Optional.

### Additional Features

**Proven, rugged rheostat control technology** that has been in Miller engine drives for over 60 years. Contains no printed control boards.

A **Stick/TIG switch** optimizes open-circuit voltage for Stick welding and allows the open-circuit voltage to be lowered for scratch start TIG welding.

Provisions are provided to plug a **RHC3GD34A remote control** that will allow precise adjustment of amperage without walking back to the machine.

# Big Blue 400 and 500 CC/CV Specifications (Subject to change without notice.)



Model	Welding Mode	Weld Output Range	Weld Output Rated at 104°F (40°C)	Max. Open-Circuit Voltage	Generator Output Rated at 104°F (40°C)	Dimensions**	Weight (without fuel)***
Big Blue 400 CC/CV	CC/DC CV/DC	20–550 A 14–40 V	400 A at 36 V (14.4 kW),* 100% Duty Cycle 450 A at 38 V (17.1 kW),* 60% Duty Cycle 500 A at 34 V (17 kW), 40% Duty Cycle	95	<b>Peak:</b> 5500 watts <b>Continuous:</b> 4000 watts, 34/17 A, 120/240 VAC, 50/60 Hz while welding	H: 43 in (1092 mm) W: 28-1/2 in (724 mm) D: 64-7/16 in (1637 mm)	<b>Perkins:</b> 1545 lb (701 kg) <b>Deutz:</b> 1655 lb (751 kg)
Big Blue 500 CC/CV		20–600 A 14–40 V	500 A at 40 V (20 kW),* 100% Duty Cycle 550 A at 42 V (23.1 kW), 60% Duty Cycle 600 A at 34 V (20.4 kW), 40% Duty Cycle				<b>Perkins:</b> 1565 lb (710 kg) <b>Deutz:</b> 1695 lb (769 kg)

\*NEMA EW1 (ANSI C87.1) Class (1) output ratings. \*\*Additional 7 in (178 mm) to top of exhaust. \*\*\*Additional 190 lb (86 kg) when fuel tank is full.

CSA certification by Canadian Standards Association.

## Big Blue 400 and 500 CC/CV Control Panel

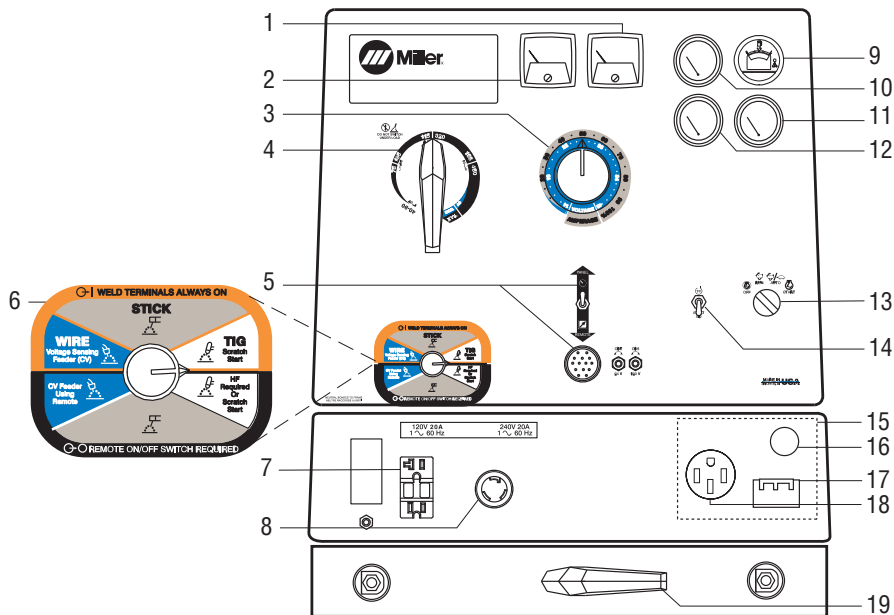

1. DC Ammeter
  2. DC Voltmeter
  3. Amperage/Voltage Adjust Control
  4. Amperage Range Switch
  5. Amperage/Voltage Adjust Switch and Remote Amperage/Voltage Adjust Receptacle
  6. Process/Contactor Selector Switch
  7. 120 VAC, 20 A GFCI Duplex Receptacle
  8. 240 VAC, 30 A TwistLock Receptacle (NEMA L6-30)
  9. Fuel Gauge/Hour Meter/Oil Change Interval Engine Shutdown Indicator
  10. Engine Oil Pressure Gauge
  11. Battery/Voltmeter\*
  12. Engine Coolant Temperature Gauge
  13. Engine Control Switch
  14. Starting Aid Switch
  15. 3-Phase Power Generator Option
  16. Strain Relief
  17. 50 A, 3-Phase Circuit Breaker
  18. 50 A, 120/240 V Receptacle (NEMA 14-50)
  19. Polarity Switch\*
- \*Optional.

### Additional Features

**One MIG welding range** allows precise voltage control for welding with .023–.120 in (0.6–3.2 mm) wires.

A multi-colored **process selector control** allows quick and easy process changes without having to use multiple switches.

**14-pin remote control** allows precise adjustment of amperage or voltage, along with contactor control, without walking back to the machine.

**The Vault — Superior Circuit Board Design**  
Miller's critical circuit boards are engineered to carry *low power* and *low heat* to reduce

thermal stress and minimize expansion and contraction. In contrast, our competitor's boards carry *high power* and *high heat*, making them more vulnerable to failure.

#### “The Vault” Makes Upgrading to Miller CC/CV Units Worry-Free

Concerns with circuit board reliability have resulted in some operators steering clear of CC/CV welder/generators — even though they offer a superior arc and multiple welding processes. Miller's circuit board reliability isn't a concern since all PRO 300 and Big Blue multiprocess industrial engine drives feature the Vault.

Created out of two aluminum halves sealed with silicone, as well as watertight harness connections, the Vault provides a clean circuit board environment, protecting the electronics — and controlling output — in heavy industrial applications. No other competitor protects their electronics with a sealed vault, leaving critical circuit boards exposed to harsh elements that can disrupt the machine's electronics, and therefore, its operation.



# Big Blue 400 and 500 CC Performance Data

**400 CC  
VOLT/AMP CURVES – STICK MODE**

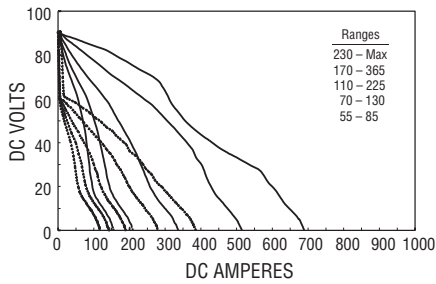

**500 CC  
VOLT/AMP CURVES – STICK MODE**

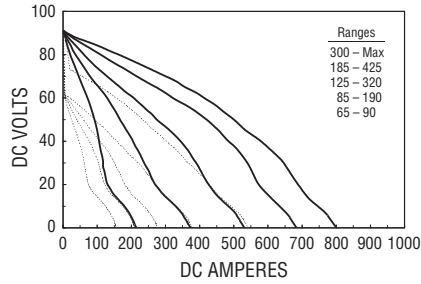

**GENERATOR POWER CURVE**

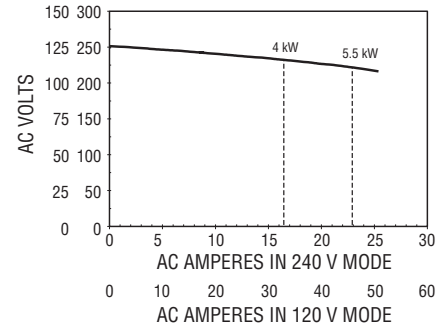

**FUEL CONSUMPTION CURVE**

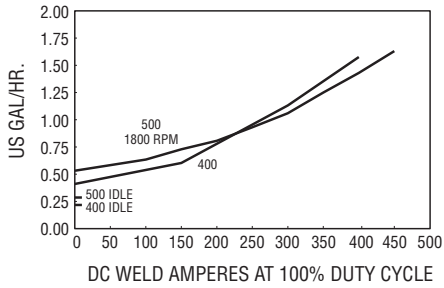

**DUTY CYCLE CURVE**

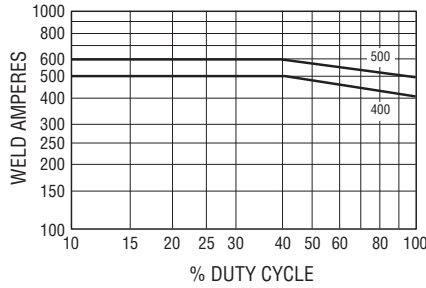

# Big Blue 400 and 500 CC/CV Performance Data

**400 CC/CV  
VOLT/AMP CURVES – STICK MODE**

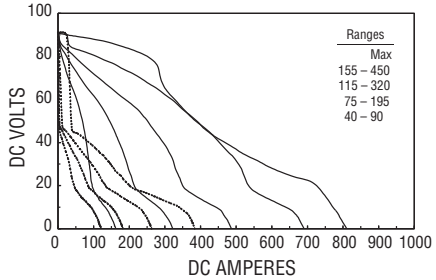

**500 CC/CV  
VOLT/AMP CURVES – STICK MODE**

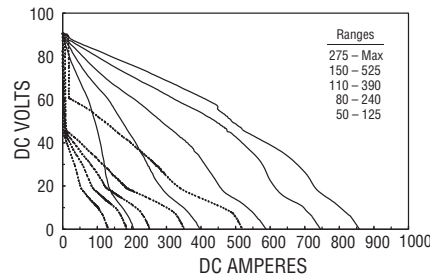

**3-PHASE GENERATOR  
POWER CURVE**

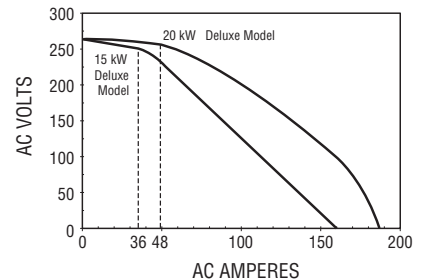

**400 CC/CV  
VOLT/AMP CURVES – MIG MODE**

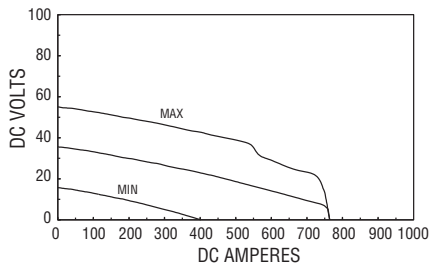

**500 CC/CV  
VOLT/AMP CURVES – MIG MODE**

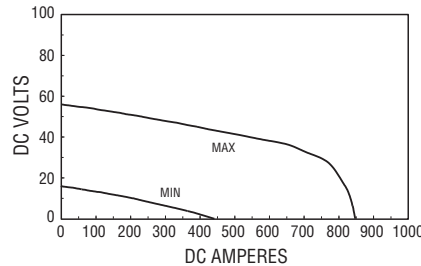

**DUTY CYCLE CURVE**

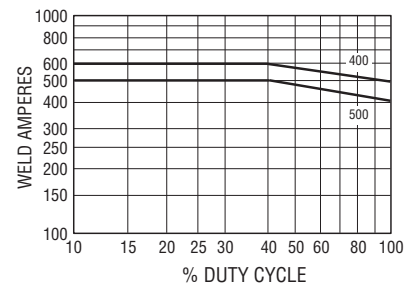

**400 CC/CV  
VOLT/AMP CURVES – TIG MODE**

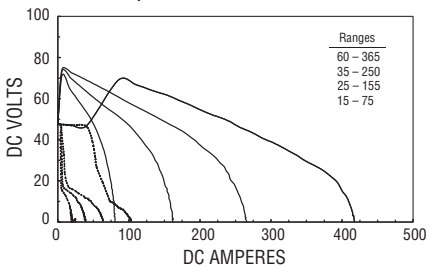

**500 CC/CV  
VOLT/AMP CURVES – TIG MODE**

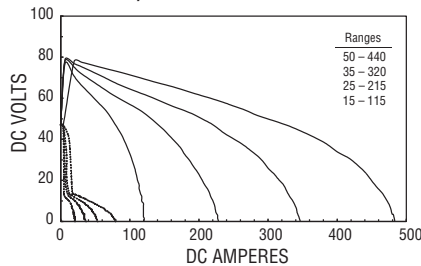

**FUEL CONSUMPTION CURVE**

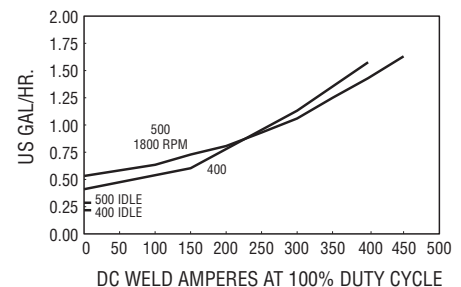

## Engine Specifications (Subject to change without notice.)

Model	Engine Brand	Features	HP	Type	Engine Speeds (RPM)	Capacities	Automatic Engine Shutdowns
Big Blue 400	Perkins 404D.22	Tier III, EPA-certified, indirect-injected, liquid-cooled engine with full load <b>sound levels of 73.2 dB @ 7 m (98 Lwa)</b> . Right-side service access with service intervals of <b>500 hours for oil and filters</b> .	32.6	4-cylinder, industrial, liquid-cooled diesel	Weld: 1800 Idle: 1235*	Fuel: 25 gal (95 L) Oil: 9 qt (8.5 L) Coolant: 9 qt (8.5 L)	Low Oil Pressure, High Coolant Temperature, Low Fuel Level
	Deutz D2011L03i	Tier III, EPA-certified, direct-injected, air/oil-cooled engine with full load <b>sound levels of 76.8 dB @ 7 m (101.7 Lwa)</b> . Right-side service access with service intervals of <b>1000 hours for oil and filters</b> . Approved <b>underground</b> operation with the purchase of a <b>MSHA (30 CFR part 7)</b> certificate.	32.0	3-cylinder, industrial, air/oil-cooled diesel	Weld: 1800 Idle: 1235*	Fuel: 25 gal (95 L) Oil: 6.2 qt (5.9 L) Coolant: Integrated oil	Low Oil Pressure, High Coolant Temperature, Low Fuel Level
Big Blue 500	Perkins 404D.22T	Tier III, EPA-certified, turbo-charged, direct-injected, liquid-cooled engine with full load <b>sound levels of 73.2 dB @ 7 m (98 Lwa)</b> . Right-side service access with service intervals of <b>500 hours for oil and filters</b> .	44.35	4-cylinder, industrial, liquid-cooled diesel	Weld: 1800 Idle: 1235*	Fuel: 25 gal (95 L) Oil: 6.5 qt (6.2 L) Coolant: 9 qt (8.5 L)	Low Oil Pressure, High Coolant Temperature, Low Fuel Level
	Deutz D2011L04i	Tier III, EPA-certified, direct-injected, air/oil-cooled engine with full load <b>sound levels of 76 dB @ 7 m (101 Lwa)</b> . Right-side service access with service intervals of <b>1000 hours for oil and filters</b> . Approved <b>underground</b> operation with the purchase of a <b>MSHA (30 CFR part 7)</b> certificate.	48.6	4-cylinder, industrial, air/oil-cooled diesel	Weld: 1800 Idle: 1235*	Fuel: 25 gal (95 L) Oil: 9 qt (8.5 L) Coolant: Integrated oil	Low Oil Pressure, High Coolant Temperature, Low Fuel Level

\*Optional on select models.

## Genuine Miller Options

### Weld Ammeter and Voltmeter Kit

#195 131 Field

Panel-mounted analog meters monitor welding output.

Installation time: 35 minutes

### Battery Voltmeter

#195 454 Field

Monitors battery charging circuit.

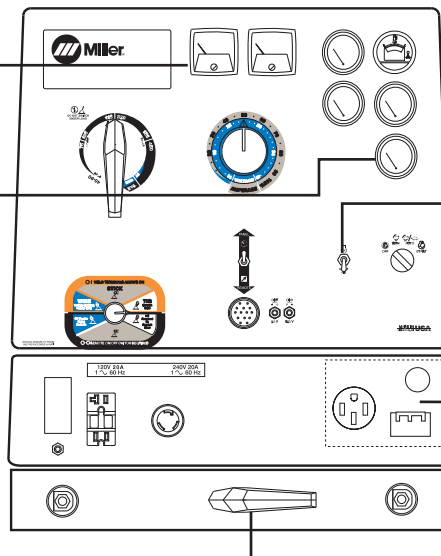

### Polarity Reversing Switch Kit

#043 942 Field

Changes DC polarity without the use of tools.

Installation time: 35 minutes

### Cold Weather Starting Aid Kit

Note: Perkins 404.22 models come standard with glow plugs.

#195 056 Field

Perkins. 120 volt block heater.

#195 307 Field

Deutz F3L2011/ F4L2011. 12 volt intake manifold heater.

#195 087 Field

Deutz F3L2011/F4L2011. 120 volt oil pan heater.

### 3-Phase Power Generator Factory (Deluxe CC/CV model only)

For Big Blue 400 CC/CV. 15,000 watts.

For Big Blue 500 CC/CV. 20,000 watts.

Adds three-phase, 240 V power to CC/CV units. 12 kW, 120/240 V single-phase power from a 50 amp receptacle. Optimum kW performance achieved while not welding. This option also includes a 50 amp on/off circuit breaker for both single- and three-phase power, and a strain relief for hard wiring into the unit.

Note: Available as factory option. See Ordering Information on back page.

For matching plug, order #119 172

# Genuine Miller Accessories



**FA-1D Lockable Flame Arrestor Fuel Cap #043 947** Field  
Fuel cap can be padlocked to prevent vandalism. A built-in flame arrestor prevents flames or sparks from entering the fuel tank.

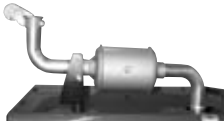

**Spark Arrestor Muffler Kit #195 012** Field  
Prevents particles

from leaving the muffler that could potentially start a fire. Mandatory when operating on California grasslands, brush, or forest-covered land, and in all National Forests. For other areas, check your state and local laws. Meets US Forest Service standard 5100-1B.



**Vandalism Lockout Kit #195 118** Field  
Lockable hinged steel panels cover and protect name plate gauges and ignition switch (padlock included). Also includes engine compartment door lock and key.



**Cable Holder #043 946**  
Saddle-bag-style cable holder. Convenient wrap-around storage of coiled cable for transportation. Stores 100 ft of 2/0 cable on each side.

*Note: For best results do not weld when cable is coiled! Canvas cover cannot be used with cable holder.*



**Roll Cage/Drip Pan #194 918** Field  
Heavy-duty galvanized steel structure designed to protect the machine. The roll cage meets offshore oil

platform requirements with a drip pan and drain plug along with a heavy-duty lift eye.



**Canvas Cover (Blue) #194 683** Field  
Attractive, waterproof canvas cover resists stains and mildew, and protects the finish of your welder.

*Note: Canvas cover cannot be used with cable holder.*

## Stick (SMAW) Welding

### Weld Leads

- #173 851** 2/0, 350 A, 100% duty cycle, 50 ft stinger, 50 ft work cable
- #043 952** 2/0, 300 A, 100% duty cycle, 100 ft stinger, 50 ft work cable

## Plasma Cutting



- Spectrum® 375 X-TREME™ #907 303**
- Spectrum® 375 X-TREME™ with X-CASE™ #907 339** (not shown)  
See Lit. Index No. PC/9.2.
- Spectrum® 625 #907 058**  
See Lit. Index No. PC/9.5.
- Spectrum 2050 #903 777-01-2**  
See Lit. Index No. PC/7.0.

## MIG (GMAW) or Flux Cored (FCAW)



**Millermatic® Passport® Plus #907 401**  
Portable, all-in-one MIG package features ultimate arc performance, self-contained gas

bottle, and flexibility to plug into 115 or 230 V power with Miller exclusive Multi-Voltage Plug. See Lit. Index No. DC/12.53.



- SuitCase™ X-TREME™ 8VS Wire Feeder #300 093**
- SuitCase™ X-TREME™ 12VS Wire Feeder #195 500**  
Lightweight, voltage-sensing wire feeders include secondary contactor and gas valve. Require drive roll kit. See Lit. Index No. M/6.41.



- SuitCase™ 8RC Wire Feeder #194 938**
- SuitCase™ 12RC Wire Feeder #194 940**  
Lightweight and flexible enough to run a variety of wires up to .062 in diameter. Comes standard with remote voltage control. See Lit. Index No. M/6.5.

**MIG (GMAW)/Flux Cored (FCAW) Guns**  
Miller produces a complete line of dependable MIG guns. See Lit. Index Nos. AY/15.0, AY/16.0 and AY/17.0.



**Spoolmatic® 30A Spool Gun #130 831**  
Air-cooled, 200-amp, 1-lb spool gun for aluminum MIG. See Lit. Index No. M/1.73.

**WC-24 Control #137 549**  
Use with Spoolmatic 30A.

**XR™ Wire Feeders and Guns**  
Push-pull system designed to handle difficult-to-feed soft alloy wires such as aluminum. See Lit. Index No. M/1.7, M/1.71, and M/1.73.

## TIG (GTAW) Welding



**Dynasty® 200 Series**  
For premium portable AC/DC TIG arc quality. See Lit. Index No. AD/4.8.



**HF-251 Series #042 388**  
HF-251D-1, 115 VAC  
**#042 387**  
HF-251D-2, 230 VAC  
High-frequency arc starter and stabilizer.

See Accessory Lit. Index No. AY/5.0.

## Genuine Miller Accessories (Continued)

### Remote Controls (CC models only)



**RHC-3GD34A Remote Hand Control #041 122**  
Allows for precise adjustment of amperage. Includes 20 ft (6 m) cord.



**RFCS-14 HD Foot Control #194 744**  
Foot current and contactor control. 20 ft (6 m) cord and 14-pin plug.



**RCC-14 Remote Contactor and Current Control #151 086**  
14-pin plug. Rotary-motion fingertip control fastens to TIG torch using two Velcro® straps. Includes 28 ft (8.5 m) control cord.

### Remote Controls (CC/CV models)



**RHC-14 Hand Control #129 340**  
Miniature hand control for remote current and contactor control. Dimensions: 4 x 4 x 3-1/4 in (102 x 102 x 82 mm). Includes 20 ft (6 m) cord and 14-pin plug.



**RMLS-14 #129 337**  
Fingertip momentary- and maintained-contact rocker switch for contactor control. Push forward for maintained contact and back for momentary contact. Includes 20 ft (6 m) cord and 14-pin plug.



**RCCS-14 Remote Contactor and Current Control #043 688**  
Up-and-down rotary-motion fingertip control fastens to TIG torch using two Velcro® straps. Includes 28 ft (8.5 m) control cord.

### Extension Cords for 14-Pin Remote Controls

**#122 973** 25 ft (7.6 m)  
**#122 974** 50 ft (15.2 m)  
**#122 975** 75 ft (22.9 m)

## Trailers and Hitches (For both models.)



**4 West Four-Wheel Steerable Off-Road Trailer #042 801**  
A heavy-duty 2570 lb (1166 kg) capacity trailer designed for use in mines, quarries, and other rough terrain. Has narrow 22 ft (6.7 m) turning radius. Includes 3 in lunette eye, universal hitch and safety chains.  
*Note: Trailer is shipped unassembled.*



**HWY-224 Trailer #043 805** For highway use.  
**OFR-224 Trailer #043 802** For off-road use.  
A 2650 lb (1202 kg) capacity trailer. Welded steel tubing frame, heavy-duty axle with roller bearing hubs and leaf-spring suspension. Includes jack stand, 2 in (50 mm) ball hitch. *HWY-224 also includes fenders and lights.*  
*Note: Trailer is shipped unassembled.*



**HWY-430 Tandem Axle Trailer #043 806**  
Smooth riding with 3750 lb (1701 kg) capacity. Includes hand-operated parking brake, hydraulic brake system, and a break-away device to lock brakes if the trailer comes loose. Includes jack stand, fenders and lights. (Hitch must be ordered separately.)  
*Note: Some assembly required.*

**Cable Tree #043 826**  
Provides an area to conveniently wrap weld cables and extension cords.

**Cable Tree #043 826**  
Provides an area to conveniently wrap weld cables and extension cords.

**Lunette Eye 2-1/2 in (64 mm) #043 824**

**Ball Hitch 2 in (50 mm) #043 864**

**Lunette Eye 3 in (76 mm) #043 863**

### Trailer Specifications (Subject to change without notice.)

Model	Gross Axle Weight Rating	Gross Vehicle Weight Rating	Net Payload	Height of Bed	Road Clearance	Track (Center to center of tires)	Standard Tires (Standard rating or P-size rating)	Dimensions	Net Weight
4 West	2000 lb/axle (907 kg/axle)	3000 lb (1361 kg)	2570 lb (1166 kg)	21-1/4 in (540 mm)	8 in (203 mm)	55-1/4 in (1403 mm)	B78-13	Length: 91 in (2311 mm)** Width: 61-1/4 in (1556 mm)	430 lb (195 kg)
HWY-224 OFR-224	3500 lb (1588 kg)	2960 lb (1343 kg)	2650 lb (1202 kg)	18-1/2 in (470 mm)	7-1/2 in (191 mm)	52 in (1321 mm)	B78-13B	Length: 122-1/2 in (3112 mm) Width: HWY- 61 in (1549 mm)* OFR-58-1/2 in (1486 mm)	355 lb (161 kg)
HWY-430	2200 lb/axle (998 kg/axle)	4280 lb (1941 kg)	3750 lb (1701 kg)	19-1/4 in (489 mm)	8-1/2 in (216 mm)	52 in (1321 mm)	B78-13B	Length: 156-1/2 in (3975 mm) Width: 61 in (1549 mm)*	530 lb (240 kg)

\*Width at outside of fenders. \*\*Does not include tongue.

# Ordering Information

Equipment and Factory Options	Stock No.	Description	Qty.	Price
<b>Big Blue® 400 CC</b>	<b>#907 173</b> <b>#907 175</b>	Deutz F3L2011 with engine gauges Perkins 404.22 with engine gauges		
<b>Big Blue® 400 CC/CV</b> Deluxe Model Deluxe Model	<b>#907 327</b> <b>#907 329</b>	Deutz F3L2011 with engine gauges, automatic idle, weld meters, 15 kW Perkins 404.22 with engine gauges, automatic idle, weld meters, 15 kW		
<b>Big Blue® 500 CC</b>	<b>#907 181</b>	Deutz F4L2011 with engine gauges		
<b>Big Blue® 500 CC/CV</b> Deluxe Model Deluxe Model	<b>#907 331</b> <b>#907 333</b>	Deutz F4L2011 with engine gauges, automatic idle, weld meters, 20 kW Perkins 404.22T with engine gauges, automatic idle, weld meters, 20 kW		
<b>Field Kit Accessories</b>				
Weld Ammeter and Voltmeter	<b>#195 131</b>	For all models, analog welding meters		
Polarity Reversing Switch	<b>#043 942</b>	For all models, DC polarity switch		
Cold Weather Starting Aids	<b>#195 056</b> <b>#195 307</b> <b>#195 087</b>	Perkins, 120 volt block heater Deutz F3L2011 and F4L2011, 12 volt intake manifold heater Deutz F3L2011 and F4L2011, 120 volt oil pan heater		
Battery Voltmeter	<b>#195 454</b>	For all models, analog		
Lockable Fuel Cap Flame Arrestor	<b>#043 947</b>	For all models, padlock not included		
Spark Arrestor Muffler	<b>#195 012</b>	For all models, horizontal externally mounted		
Vandalism Lockout Kit	<b>#195 118</b>	For all models, lockable front control panel and engine compartment		
Cable Holder	<b>#043 946</b>	For all models, stores up to 200 ft of 2/0 weld cable		
Roll Cage/Drip Pan	<b>#194 918</b>	For all models, meets offshore oil platform requirements		
Protective Cover	<b>#194 683</b>	For all models, <b>will not work with cable holder accessory</b>		
<b>Stick Accessories</b>				
Accessory Kits	<b>#173 851</b> <b>#043 952</b>	2/0, 350 A, 100% duty cycle, 50 ft (15 m) stinger, 50 ft (15 m) work clamp 2/0, 300 A, 100% duty cycle, 100 ft (30.5 m) stinger, 50 ft (15 m) work clamp		
<b>MIG/Flux Cored Accessories</b>				
Millermatic® Passport® Plus	<b>#907 401</b>	Includes gas bottle and MVP. See Lit. Index No. DC/12.53		
SuitCase™ X-TREME™ 8VS and 12VS	<b>#300 093/#195 500</b>	See Lit Index No. M/6.41		
SuitCase™ 8RC and 12RC	<b>#194 938/#194 940</b>	See Lit Index No. M/6.5		
MIG (GMAW)/Flux Cored (FCAW) Guns		See Lit Index Nos. AY/15.0, AY/16.0 and AY/17.0		
Spoolmatic® 30A Spool Gun	<b>#130 831</b>	Requires WC-24 Control. See Lit. Index No. M/1.73		
WC-24 Control	<b>#137 549</b>	See Lit. Index No. M/1.5		
XR™ Wire Feeder Control and Guns		See Lit. Index No. M/1.7, M/1.71, and M/1.73		
<b>TIG Accessories</b>				
Dynasty® 200 Series		See Lit Index No. AY/4.8		
High Frequency Arc Starters		See Lit. Index No. AY/5.0		
<b>Remote Controls</b>				
RHC-3GD34A	<b>#041 122</b>	CC models only, hand control		
RHC-14	<b>#129 340</b>	CC/CV models only, amperage or voltage control		
RFCS-14 HD	<b>#194 744</b>	CC/CV models only, foot control		
RMLS-14	<b>#129 337</b>	CC/CV models only, momentary and maintained contact switch		
RCC-14	<b>#151 086</b>	CC/CV models only, fingertip control		
RCCS-14	<b>#043 688</b>	CC/CV models only, fingertip control		
Remote Control Extension Cords		See page 6		
<b>Trailers and Hitches</b>				
4-West Trailer	<b>#042 801</b>	4-wheel steerable implement trailer		
HWY-224 Trailer	<b>#043 805</b>	Trailer with lights, fenders and 2 in ball hitch		
OFR-224 Trailer	<b>#043 802</b>	Trailer with 2 in ball hitch		
Lunette Eye, 2-1/2 in	<b>#043 824</b>	Replaces the 2 in ball hitch on the HWY-224 or OFR-224		
Cable Tree	<b>#043 826</b>	Trailer mounted cable holder for HWY-224, OFR-224 or HWY-430		
HWY-430 Trailer	<b>#043 806</b>	Hitch required		
Ball Hitch, 2 in	<b>#043 864</b>	For HWY-430 only		
Lunette Eye, 3 in	<b>#043 863</b>	For HWY-430 only		

Date:

Total Quoted Price:

Distributed by:

